

DRAM

ELECTRONICS LTD.

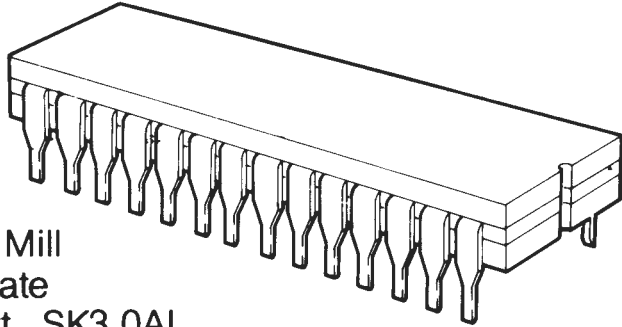

Unit 12,
Kingston Mill
Chestergate
Stockport SK3 0AL

Tel: 061-429 0626
Tlx: 312242

Micronet 800 Dealer Link 72:DTB10103



Computer Catalogue

IBM ★ Amstrad ★ Commodore
Acorn ★ Spectrum

INDEX

	Page
IBM	3 - 5
Epson	4 - 5
Commodore	5
Cables	8
Sinclair	9
Monitors & Upgrades	10
Acorn	11 - 26
Tapes & Cassettes	27 - 29
Joysticks	30 - 31
Disc Accessories	32

<u>PC / AT Peripheral Cards</u>		
DR48	PC 5/8M Mother board no BIOS	133.75
DRAT	AT 8/10M M/board 2 Ser port	600.00
DRATb	AT 6/10M M/Board small outline	437.04
DR17	PC Keyboard	80.00
DR18	PC Casing hinge top full size	61.25
DR20	Falcon DOS	48.75
DR35	150W Power supply	82.23
DR36	200W Power supply	144.45
DR70	Non interruptable PSU	256.25
DR04	Floppy Disc Controller	44.43
DR34	Floppy d/drive cable	9.50
DR19	360K Disc Drive 1/2 Height	99.00
DR12	Hard Disc Controller Card	120.00
DR13	20 Meg Winchester ST225A	180.00
DR14	20 Meg Winchester 35 nS	350.00
DR15	70 Meg Winchester	700.00
DR75	20 M Tape Streamer	843.75
DR05	Hercules Type Card	72.94
DR10	Colour/Graf + Printer Comp mono	95.55
DR11	As above - Printer	75.55
DR56	EGA Card	199.00
DR53	Green TTL Monitor	92.94
DR54	Amber TTL Monitor	95.30
DR06	Single Port Serial	32.95
DR06A	Dual Port Serial	45.00
DR71	Serial / Par card AT only	73.75
DR72	As Above PC only	60.00
DR79	4 Port serial card PC only	175.00
DR79A	As above for AT	200.00
DR08	384K Multi Pri/Ser/Cl/Cal 0 RAM	99.00
DR08A	As above fully populated	137.00
DR32	576K RAM Card	35.40
DR32A	As above +RAM	91.20
DR68	2.5M RAM Above board card	188.88
DR68a	DR 68 + RAM	422.88
DR69	3.5M RAM Board	188.88
DR69a	As above + RAM	516.40
DR07	Printer Card	26.68
DR33	Printer Cable	9.50
DR43	Clock calender card	31.11
DR49	Multi I/O Card	98.75
DR80	12 Bit A/D D/A Card	148.89
DR73	Bar code reader	261.25
DR81	286 Accelerator	373.33
DR82	286 Accelerator 10 M	488.88
DR83	386 Accelerator	poa.

DISCOUNTS

Buy any mix of:

5	10%
10	20%
25	25%
50	30%
100	40%

Applies to ALL
cards except
winchesters,
&
MCS Buffers.

DRAM New Range PC Plug in cards PAL/PROM Programmars

PAW401	PAL Prog	3	385.00
UPW48A	8748/9/1/2	1	252.00
UPW48B	4xTEXT00L	2	315.00
ICT301	TTL/CMOS TESTER	2	176.40
EW901	PROM PROG.1WAY	9	176.40
EW904	" 4WAY	11	238.00
EW910	" 10WAY	5	470.40
ETC010	Extension Card	1	39.20
EPS011	As above + Cable	0	46.20

Buffers

MCS-IBS-64	Internal serial	64K	149.00
MCS-IBS-256	"	256K	199.00
MCS-IBS-512	"	512K	249.00
MCS-IBP-64	Internal Parallel	64K	149.00
MCS-IBP-256	"	256K	199.00
MCS-IBP-512	"	512K	249.00
DR190			113.33

EPSON PRINTERS Printers and Inerfaces.

ON EPSON PRINTERS DEALERS QUALIFY FOR 20% DISCOUNT

GX80	Parallel Matrix Printer	249.00
LX86	Parallel Matrix Printer	275.00
FX105	Parallel Matrix Printer	569.00
FX800	Parallel Matrix Printer	430.00
FX1000	Parallel Matrix Printer	550.00
H180	Parallel Colour Printer	400.00
LQ800	NLQ Matrix Printer	625.00
LQ1000	NLQ Matrix Printer	835.00
LQ2500	NLQ Matrix Printer	1045.00
SQ2500	Ink Jet Printer	1345.00
EX800	Serial and Parallel Printer	555.00
EX1000	Serial & Parallel Printer	745.00

Optional Interfaces for above range.

8143	Serial Interface	31.90
8145	2K Serial Interface	66.00
8148	2K XON-XOFF Serial Interface	71.50
8165	2K Interfaxe IEEE	71.50
8171	2K Parallel Interface	60.00
8132	W Apple 2 Parallel Interface	52.80
8177	NLQ Board Parallel 2K or 6K B	99.00
8647	NLQ Board Ser./Par 2K or 6K B	109.00
8190	WP Board for FX100+	79.00
8172	32K Parallel Buffer	114.73

Laser Printers

Epson Laser printer	1750.00
---------------------	---------

ACCESSORIES

LX80/GX80 Tractor 8304	22.00
LX80/GX80 CSF 8338	60.50
FX80/85 CSF 8331	137.50
FX100/105 CSF 8333	173.00
FX800 CSF 8347	141.90
FX1000 CSF 8343	163.90
HI80 HPGL ROM 6493	55.00
HI80 HPGL RAM 6490	70.00
LQ800 Tractor 7303	44.00
LQ800 CSF 7333	148.50
LQ1000 Tractor 7304	55.00
LQ1000 CSF 7334	173.25

<u>Description</u>	<u>Qty</u>	<u>100+</u>	<u>500+</u>	<u>1000+</u>
--------------------	------------	-------------	-------------	--------------

Floppy discs 3 Inch

SS/DD	69	2.80	2.50	
DS/DD	45	4.50	4.10	

Floppy Discs 3.5 Inch

SS/DD	750	1.89	1.65	1.55
DD/DD	250	2.79	2.39	2.25

Prices for UNBRANDED Discs shrink wrapped in 25 piece packs with envelope, hub ring, write protect & library labels. For A.I.M. BRANDED Discs add 10p per disc packed in 10s & shrink wrapped

Floppy Discs 5.25 Inch

SD/DD 40-48 TPI	900	.75	.65	.57
DS/DD 40-48 TPI	12500	.85	.75	.68
SS/DD 80-96 TPI	400	.95	.81	.75
DS/DD 80-96 TPI	1790	1.05	.91	.85
DS/HD 1.6M	500	1.99	1.79	2.09

Computer Cassettes

C10	600	0.280	0.250	0.240
C15	400	0.300	0.270	0.260
C20	1000	0.35	0.28	0.27
C90	190	0.40	0.35	0.30

Commodore Spares

901-225	38	12.00		
901-226	33	12.00		
901-227	36	12.00		
906-114 PLA	46	4.84		
6502A	1030	4.45	3.85	3.50
65C02A	10	7.06	6.25	5.25
6510	12	12.00		
6522A	267	3.80	3.10	2.86
6526	16	7.56		
6569	31	12.00		
6581	42	12.00		
Commodore Cassette	5	16.00		

Telephone 061-429 0626

T177	1.20
T178	1.25
T179	1.20
T180	1.20
T180A	.70
T181	.55
T182	.70
T183	1.20
T184	.90
T185	1.35
T185A	.90
T185B	.95
T185C	1.15
T185D	2.50
T185E	1.35
T185F	.95
T185G	1.00
T185H	4.05
T107	1.40
T109	1.25
T111	.60
T191A	4.90
T104	1.00
T104A	1.00
T105	.75
T105D	.60
F319B	3.77
F319C	4.38
F319D	4.58

Cables & Leads

Commod Monit. A109	100	0.72	0.55	0.55
7P DIN/7P DIN T179	1200	1.20	0.79	0.79
5P DIN/5P DIN A099	1700	0.55	0.50	0.50
5P DIN/3 Jack T180	190	1.20	0.78	0.78
7P DIN/3 Jack T177	700	1.20	0.78	0.78
6P DIN/6DIN T185C	400	1.15	0.76	0.76
5P dom/5P dom T185G1500		0.85	0.78	0.65
CENTR/CENTR T191C	20	7.35	6.67	6.40
BBC PRINTER	205	1+ 6.50	25+ 5.95	100+ 4.42
Compact Printer	5	1+ 9.50		
AMSTRAD RIBBON	50	1+ 8.00	25+ 7.00	100+ 6.25
PHONO/PHONO 2 M	110	1.02	.90	.80
BNC/PHONO T109	200	1.25	.82	.82
BNC/BNC	100	1.40	1.14	1.14
UK MAINS/CEE22 6A	1000	2.20	1.95	1.56
Mains Plugs	1240	.40	.36	.30
Mains Plugs Sleeved	900	.70	.65	.60

THIS IS ONLY A SMALL SELECTION FROM OUR RANGE PLEASE ASK FOR OUR SPECIAL PRODUCTS CATALOGUE

Telex 312242 · Mid Telex DRAM

COMPUTER LEADS

All cables screened. Connectors colour coded where necessary.

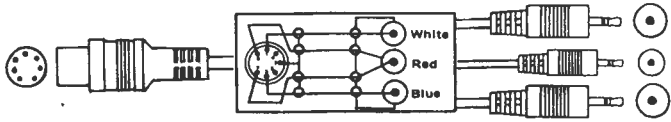

T177 **7X3C**
 7-pin DIN plug to two 3.5mm and one 2.5mm jack plugs. Colour grey.
 Length:..... 1.2m



T178 **7X2C**
 7-pin DIN plug to 3-pin DIN plug and 2.5mm jack plug. Colour grey.
 Length:..... 1.2m

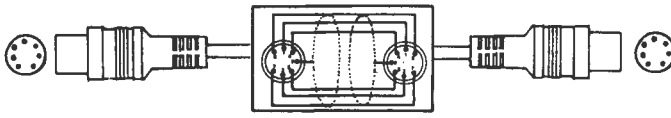

T179 **7X1C**
 7-pin DIN plug to 7-pin DIN plug. Colour grey.
 Length:..... 1.2m

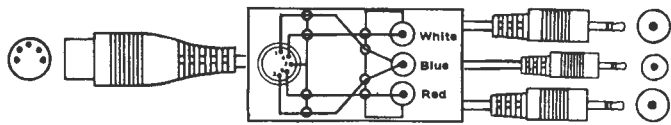

T180 **5X3C**
 5-pin DIN plug to two 3.5mm and one 2.5mm jack plugs. Colour grey.
 Length:..... 1m

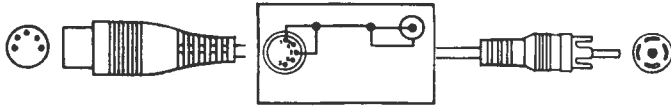

NEW
T180A **5X1R**
 5-pin DIN plug to phono plug.
 Length:..... 3m

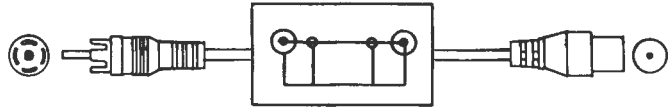

T181 **1X1C**
 Phono plug to co-axial TV aerial plug. Colour grey.
 Length:..... 1.2m

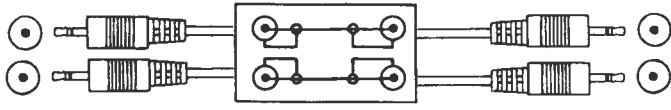

T182 **2X2C**
 Two 3.5mm jack plugs to two 3.5mm jack plugs. Colour grey.
 Length:..... 1.2m

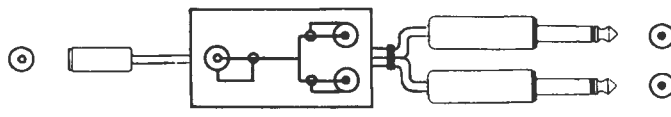

T183 **1X26C**
 One 3.5mm mono jack socket to two 6.35mm mono jack plugs. For recording programmes onto high quality stereo cassette recorders. Colour grey.
 Length:..... 2m

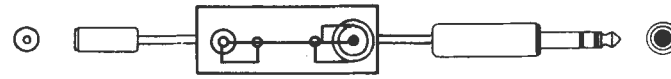

T184 **1X16C**
 One 3.5mm mono jack socket to one 6.3mm stereo jack plug. For loading programmes from high quality stereo audio systems. Colour grey.
 Length:..... 2m

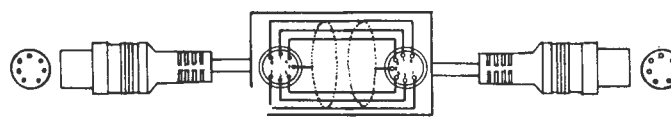

T185 **7X7C**
 7-pin DIN plug to 7-pin DIN socket. All contacts connected. Extension lead. Colour grey.
 Length:..... 2m

COMPUTER LEADS

SCREENED CONNECTION LEADS

Made from highest quality flat black cable, each core individually screened.
Connectors are all moulded-on to give a modern styled appearance.



T185A **RR55**
5-pin 180° DIN plug to 5-pin 240° DIN plug. For connection between computer and cassette player.
Length:..... 1.2m



T185B **RRGB5D**
6-pin DIN plug to 5-pin 180° DIN plug. For connection between ORIC, DRAGON 32, etc and RGB colour monitor.
Length:..... 1.2m

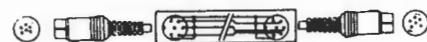

T185C **RRGBX2**
6-pin DIN plug to 6-pin DIN plug. Standard RGB connector. For BBC, Commodore, Apple, Dragon 64, etc.
Length:..... 1.2m

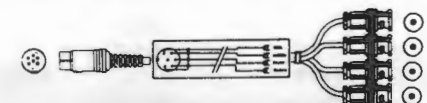

T185D **RRGBB**
6-pin DIN plug to 4 x BNC plugs. RGB connector - Computer to monitor.
Length:..... 1.2m



T185E **RRGBP**
6-pin DIN plug to 4 x phono plugs. RGB connector - Computer to monitor.
Length:..... 1.2m

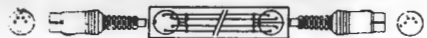

T185F **RR4D4D**
4-pin DIN plug to 4-pin DIN plug. Tandy-type printer lead, etc.
Length:..... 1.2m



T185G **RRS423**
5-pin 360° (Domino) plug to 5-pin 360° DIN (Domino) plug. Mirror image. Standard RS423 communication lead.
Length:..... 1.2m



T185H **4B4B**
4 x BNC plugs to 4 x BNC plugs professional RGB hook-up. Colour black.
Length:..... 1.2m

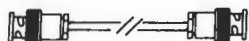

T107 **BBC12**
BNC plug to BNC plug.
Length:..... 1.2m

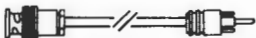

T109 **BPPC12**
BNC plug to Phono (RCA) plug.
Length:..... 1.2m

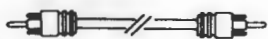

T111 **PPPCV12**
Phono (RCA) plug to Phono (RCA) plug.
Length:..... 1.2m

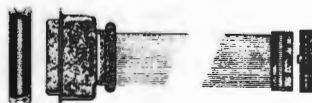

T191A **RRBBC**
26-pin IDC connector to 36-pin plug. For connection between BBC computer and printer.
Length:..... 2 metres

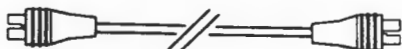

Co-axial plug to co-axial plug.

	ref.	cat.	length	colour
	T104	4TVF	4m	White
NEW	T104A	4TVFB	4m	black
	T105	2TVF	2m	white
NEW	T105D	2TVFB	2m	black

Spectrum Spares

Spectrum ULA	33	6.50
ROM	20	6.50
membrane	100	1.60
PSU	100	4.80

Upgrade to spectrum + We have 3000

PRICE #24.95



Telephone 061-429 0626

Monitors , Ex.Boards , Printers & Joysticks

1431Mvitec Cub RGB 14"	0	1+	242.61
DECCA RGB Mon/Colour TV	5		250.00
PHILIPS Mono GreenBM7502	2		80.23
PHILIPS TV / MON / COMP	1		192.57
Citizen FL20C	10		225.00
TL59F BBC JOYSTICK	107		4.40
TL65C Quickshot 2	70		5.65
Bitstick Plotter Driver	1		68.70
Bitstick 2	1		795.00
Concept Keyboard A3	0		139.50
Concept Keyboard A4	0		109.50
Cassette Recorder	26		15.50
Commodore Cassette	5		16.00

Acorn Upgrades

Master Eprom Cartridge		13.00	
Master Turbo		109.35	
Master Econet		43.47	
A To B Upgrade		42.80	
Speech Upgrade		47.83	
Econet		27.06	
Dram Econet B		20.00	16.00 14.78
Dram Econet B+		18.00	15.50 14.10
DFS LOGIC KIT		4.50	4.00 3.70
64K Upgrade		22.00	
1770 Upgrade		43.44	
MR3000 ROM Board		15.60	
MR4200 RAM Board		27.40	
MR6000 4XROM Cartridge		11.95	
MR7200 RAM Cartridge		28.95	
ATPL SIDEWISE		38.00	
ATPL SIDEWISE +		32.95	
ATPL MOUSE		29.95	

Modems & Disc Drives

Nightingale		119.48
Nightingale + Comstar		139.00
Auto Answer/dial Board		49.00
Disisolve Chip Chat A/A A/D		159.95
Disc Drive 100K SS Teac		103.00
" 200K DS		113.00
" 400K DS 40/80T		128.00
Dual Disc 400K DS 40T		210.00
" 800K DS 40/80T		244.00
Acorn 100K SS		86.00
Acorn 800K SS Inc Stand		282.61

PART No	DESCRIPTION	RETAIL	POSTAL
		PRICE	PRICE
		EXC	INC
		U.A.T.	U.A.T.
<u>BBC</u>			
0103 001	BBC Keyboard	49.89	60.82
0103 003	BBC PSU	56.00	69.00
0201 024	BBC Plastic Ruler	1.88	2.74
0201 029	ULA Heat Sink	1.10	1.84
0201 030	PSU Baseplate	1.01	2.31
0201 121	ROM Slot Cover	0.70	1.38
0201 143	Keytop Set 'Comtec'	20.83	25.10
0201 503	Aerial/TV Lead	1.21	1.97
0201 521	Cassette Lead (7-7)	3.60	4.71
0201 530	Econet Lead (5-5)	1.33	2.10
0201 608	Speech Chip IM6100	10.55	12.70
0201 628	Basic PBO5	22.50	26.45
0201 629	O/S PBO4	14.58	17.34
0201 647	Aspect Custom Chip	18.00	21.27
0201 648	Apache Custom Chip	14.68	17.46
0201 666	DNFS ROM	22.50	26.45
0350 172	Space Bar (Comtec)	0.66	1.34
0403 001	Welcome Cassette	10.73	13.49
0580 103	10K Vertical Minature	1.05	1.78
0580 204	200K Trimmer	1.05	1.78
0699 001	2.22pF Trimmer	0.91	1.62
0704 816	HM4816	1.98	2.85
0705 050	5AA 5050	10.50	12.65
0706 489	SN76489AN	7.10	8.74
0706 502	6502A CPU	8.70	10.58
0706 522	6522	6.10	7.59
0706 845	6845	8.50	10.35
0706 850	6850	2.90	3.91
0706 854	68854	8.75	10.63
0707 002	UPD7002	9.45	11.44
0708 271	8271	41.11	47.85
0733 691	DS3691N	4.30	5.52
0735 159	SN75159N	5.70	7.13
0738 095	81 LS 95	0.83	1.53
0739 120	88 LS 120	2.61	3.58
0740 038	7438	0.93	1.64
0740 045	7445	1.75	2.58
0741 000	74 S 00	0.93	1.64
0741 004	74 S 04	0.93	1.64
0741 074	74 S 74	1.15	1.89
0741 139	74 S 139	1.98	2.85
0742 000	74 LS 00	0.93	1.64
0742 002	74 LS 02	0.90	1.61
0742 004	74 LS 04	1.05	1.78
0742 010	74 LS 10	0.86	1.57
0742 020	74 LS 20	0.75	1.43
0742 030	74 LS 30	1.00	1.72
0742 032	74 LS 32	1.00	1.72

Telephone 061-429 0626



PART No	DESCRIPTION	RETAIL PRICE EXC U.A.T.	POSTAL PRICE INC U.A.T.
0742 051	74 LS 51	1.13	1.87
0742 074	74 LS 74	1.16	1.91
0742 086	74 LS 86	0.86	1.57
0742 123	74 LS 123	1.20	1.95
0742 132	74 LS 132	1.25	2.01
0742 138	74 LS 138	0.91	1.62
0742 139	74 LS 139	1.08	1.82
0742 163	74 LS 163	1.35	2.12
0742 244	74 LS 244	1.18	1.93
0742 245	74 LS 245	2.50	3.45
0742 251	74 LS 251	1.05	1.78
0742 259	74 LS 259	1.15	1.89
0742 273	74 LS 273	2.25	3.16
0742 283	74 LS 283	1.60	2.41
0742 393	74 LS 393	1.60	2.41
0744 245	74 ALS 245	9.25	11.21
0754 013	4013	1.21	1.97
0754 020	4020	1.36	2.14
0770 319	LM319	3.00	4.02
0770 324	LM324	0.91	1.62
0770 386	LM386	1.16	1.91
0770 555	LM555	0.91	1.62
0780 239	BC239	0.36	0.99
0780 309	BC309	0.36	0.99
0783 906	2N3609	0.60	1.26
0794 148	1N4148	0.11	0.70
0799 000	RED LED	0.33	0.95
0800 001	Socket MAB5WH (RS432)	0.93	1.64
0800 002	Socket MAB6H (RGB)	1.05	1.78
0800 003	Socket MAB7SHL (Cassette)	1.08	1.82
0800 004	Socket MAB5SH (Econet)	0.91	1.62
0800 006	Header 34 way	1.85	2.70
0800 007	Header 40 way	2.00	2.87
0800 008	Header 26 way	1.60	2.41
0800 009	Header 20 way	1.50	2.30
0800 050	Molex Pins 2 way	0.26	0.88
0800 051	Molex Pins 3 way	0.38	1.01
0800 054	Molex Pins 8 way	0.58	1.24
0800 055	Molex Pins 10 way	1.00	1.72
0800 059	Molex Pins Molex Pins 17	0.86	1.57
0800 070	Molex Mini Shunt	0.38	1.01
0800 108	IC Socket 8 way	0.36	0.99
0800 114	IC Socket 14 way	0.51	1.16
0800 016	IC Socket 16 way	0.56	1.22
0800 120	IC Socket 20 way	0.56	1.22
0800 124	IC Socket 24 way	0.56	1.22
0800 128	IC Socket 28 way	0.70	1.38
0800 140	IC Socket 40 way	0.81	1.51
0800 200	AMP 110 Faston Connector	0.28	0.90
0800 304	'D' Socket 15 way	2.45	3.39

PART No	DESCRIPTION	RETAIL PRICE EXC U.A.T.	POSTAL PRICE INC U.A.T.
0800 600	Socket BNC 75 ohm	1.50	2.30
0810 001	Relay BBC Cassette	1.90	2.76
0820 160	Crystal 16MHz	1.60	2.41
0820 177	Crystal 17.7345MHz	1.60	2.41
0825 000	Modulator UHF UM1233	5.40	6.78
0835 003	Loudspeaker BBC	1.50	2.30
0860 005	Choke 33mK	0.91	1.62
0870 701	Cable Assy Molex 17 Way	3.80	4.94
0882 946	Inserts Captive BBC	0.16	0.76
0886 004	Keyswitch (Futaba)	0.83	1.53
0886 005	Wire Space Bar BBC	0.16	0.76
0886 007	Support Space Bar	0.16	0.76
0890 000	Rubber Feet BBC	0.33	0.95
0999 616	Space Bar PED	1.15	1.89
0999 617	Keypop Set PED	13.75	16.96
0999 618	Keyswitch PED	0.83	1.53
0999 619	Holder Space Bar Support	0.50	1.15
0999 620	Keyswitch SMK	0.60	1.26
0999 622	Wire Space Bar SMK	0.23	0.84
0999 623	Space Bar SMK	1.05	1.20
0999 624	Keypop Set SMK	20.65	24.89
0999 625	Keyswitch SMK	0.83	1.53
0999 627	Keyswitch Wongs/SMK	0.83	1.53

BBC B PLUS

0201 241	D/S Basic ROM	22.50	26.45
0201 274	A D F S ROM	27.00	31.62
0201 880	PAL 16R4	12.80	15.29
2201 077	Plastic Ruler 64K	1.95	2.81
2201 113	1770 DFS ROM	22.00	25.87
0701 770	WD1770 FDC	36.86	42.96
0704 105	64K x 4 D-RAM	8.10	9.89
0704 865	64K D-RAM	5.00	6.32
0706 511	6512A	12.00	14.37
0741 002	74 S 02	1.01	1.74
0742 109	74 LS 109	1.06	1.80
0742 253	74 LS 253	1.30	2.07
0742 257	74 LS 257	1.11	1.85

CO-AXIAL LOW LOSS SPLITTERS

	F357 F358 F359 F360
	F361
	F361A

Telephone 061-429 0626

PART No	DESCRIPTION	RETAIL PRICE EXC U.A.I.	POSTAL PRICE INC U.A.I.
---------	-------------	----------------------------------	----------------------------------

6502 2nd Processor

0201 146	Ribbon Cable Assy.	9.75	11.78
0201 605	Tube ULA 9C018E	29.80	34.84
0201 606	Boot ROM 6502	9.00	10.92
0201 666	DNFS ROM	22.50	26.45
0201 685	MI Basic ROM	19.58	23.09
0704 164	64K D-RAM	5.00	6.32
0706 501	6502C CMOS	23.75	27.88
0738 095	81 LS 95	0.83	1.53
0741 004	74 S 04	0.93	1.64
0741 074	74 S 74	1.15	1.89
0742 000	74 LS 00	0.93	1.64
0742 002	74 LS 02	0.90	1.61
0742 074	74 LS 74	1.16	1.91
0742 122	74 LS 122	1.35	2.12
0742 133	74 LS 133	1.05	1.78
0742 161	74 LS 161	1.16	1.91
0742 163	74 LS 163	1.35	2.12
0742 393	74 LS 393	1.60	2.99
0800 037	PCB Connector 40 way	5.90	7.36
0800 200	Faston Tab	0.28	0.90
0805 003	Rocker Switch 250V 10A	1.20	1.95
0815 010	Fuse 2A QB	0.45	1.09
0815 208	Fuse 315mA SB	0.66	1.34
0820 120	Crystal 12MHz	2.15	3.04
0831 100	Power Supply	43.75	50.15
0882 946	Spire Clip No.6	0.16	0.76
0890 000	Rubber Feet	0.33	0.95

Z80 2nd Processor

0201 146	Ribbon Cable Assy.	9.75	10.10
0201 605	Tube ULA 9C018E	29.80	29.70
0201 644	Z80 Boot ROM	15.00	15.23
0201 666	DNFS ROM	22.50	22.56
0700 080	Z80 B Processor	12.05	12.35
0704 164	64K D-RAM	5.00	4.31
0738 095	81 LS 95	0.83	1.38
0741 004	74 S 04	0.93	1.48
0741 074	74 S 74	1.15	1.69
0742 000	74 LS 00	0.93	1.48
0742 004	74 LS 04	1.05	1.60
0742 011	74 LS 11	1.00	1.55
0742 032	74 LS 32	1.00	1.55
0742 074	74 LS 74	1.16	1.71
0742 123	74 LS 123	1.20	1.74
0742 132	74 LS 132	1.25	1.79
0742 133	74 LS 133	1.05	1.60

PART No	DESCRIPTION	RETAIL	POSTAL
		PRICE	PRICE
		EXC	INC
		U.A.T.	U.A.T.
0742 260	74 LS 260	1.20	1.74
0783 906	Transistor 2N3906	0.60	1.16
0800 037	PCB Connector 40 way	5.75	6.19
0800 200	Faston Tab	0.28	0.85
0805 003	Rocker Switch 250V 10A	1.20	1.74
0815 007	Fuse 1A QB	0.66	1.22
0815 207	Fuse 250mA SB	0.81	1.37
0820 120	Crystal 12MHz	2.15	2.67
0831 100	Power Supply	43.75	50.15
0860 002	Inductor 2uH	0.75	1.30
0886 946	Spire Clip No.6	0.16	0.73
0890 000	Rubber Feet	0.33	0.90

Prestel Adaptor

0201 186	Cable Assy. Telephone	7.25	8.91
0201 187	Cable RS232	2.10	2.99
0201 643	Prestel ROM	17.66	20.89
0733 691	DS 3691 N	4.30	5.52
0754 020	CD 4020 B	1.36	2.14
0754 049	HEF 4049 B	1.05	1.78
0754 071	CD 4071 BCP	0.83	1.53
0754 081	HEF 4081 B	0.88	1.59
0754 520	HEF 4520 B	1.60	2.41
0754 556	HEF 4556 B	1.50	2.30
0763 101	ICM 3101 N	23.26	27.33
0770 062	TL 062	1.43	2.22
0772 003	ULN 2003 A	1.40	2.18
0778 006	LM 341	1.40	2.18
0779 001	LM 320	1.20	1.95
0795 003	Diode Zener 3V3	0.31	0.93
0795 005	Diode Zener BZY 96 C5V1	3.85	5.00
0795 012	Diode Zener BZX 70 C12	1.70	2.53
0798 101	Bridge Rectifier 1 KAB 10	1.05	1.78
0800 050	Molex Pins 2 way	0.26	0.88
0800 051	Molex Pins 3 way	0.38	1.01
0800 070	Molex Mini Shunt	0.38	1.01
0800 080	Crimp Terminal	0.16	0.76
0800 082	Molex Housing 2 Pin Skt.	0.30	0.92
0800 200	Faston Tab	0.28	0.90
0805 003	Rocker Switch	1.20	1.95
0810 003	Relay 2P N/D (10401)	5.15	6.49
0810 004	Relay 1P N/C (10201)	4.70	5.98
0810 005	Relay 1P N/O (10101)	3.60	4.71
0815 003	Fuse 250mA QB	0.63	1.30
0815 016	Fuse 63mA QB	0.93	1.64
0815 209	Fuse 400mA SB	0.66	1.34
0820 043	Crystal 4.433619MHz	2.40	3.33
0835 001	Loudspeaker	1.38	2.16
0865 001	Mains Transformer 22289	8.13	10.50

Telephone 061-429 0626

PART No	DESCRIPTION	RETAIL PRICE EXC U.A.T.	POSTAL PRICE INC U.A.T.
0865 002	Isolation Trans'fmr 25818	7.66	9.96
0882 946	Spire Clip No.6	0.16	0.76
0890 000	Rubber Feet	0.33	0.95

Master 128

0143 050	Master Keyboard Assy.	62.77	75.64
2201 119	Numeric Keytop Set	3.86	5.59
2201 121	Master Ribbon Cable Assy.	3.25	4.31
0201 143	Alpha Keytop Set (Comtec)	20.83	25.10
0143 003	Welcome/Utils Cassette	9.16	11.69
0201 503	TU/Aerial Lead	1.21	1.97
0201 647	Video ULA	18.00	21.27
0201 648	Serial ULA	14.68	17.46
0201 793	Loudspeaker Nest	1.00	1.72
0201 805	Master Ruler	0.83	1.53
2201 134	Accessories Holder	2.46	3.41
2201 220	Welcome/Utils. Disc	11.50	14.37
0201 847	MSI I/O (CF30050)	16.45	19.49
0201 844	MSI KEYBD ENC (CF30047)	12.70	15.18
2201 213	MSI MEM Sw (CF30058)	12.60	15.06
0201 845	MSI PBC (CF30049)	12.70	15.18
2201 239	1MB ROM	39.00	45.42
0201 846	MSI CRIC MUX (CF30048)	12.70	15.18
2201 211	MSI CHROMD (CF30060)	8.40	10.23
0343 900	Battery Replacement Pack	0.00	0.00
0701 770	WD 1770 FDC	36.86	42.96
0704 105	64K x 4 D-RAM	8.10	9.89
0705 050	SAA 5050	10.50	12.65
0706 489	SN 76489	7.10	8.74
0706 512	65SC12	11.40	13.68
0706 522	6522	6.10	7.59
0706 845	6845	8.50	10.35
0706 850	6850	2.90	3.91
0706 818	6818	7.25	8.91
0707 002	7002	9.45	11.44
0709 637	UA 9637 ACP	2.40	3.33
0733 691	DS 3691 N	4.30	5.52
0740 016	7416 (Alt to 7406)	1.40	2.18
0740 038	7438	0.93	1.64
0741 000	74 S 00	0.93	1.64
0741 004	74 S 04	0.93	2.22
0742 000	74 LS 00 (Alt to 74ALS00)	0.93	1.64
0742 002	74 LS 02	0.90	1.61
0742 014	74 LS 14	0.90	1.61
0742 086	74 LS 86 (Alt to 74ALS86)	0.86	1.57
0742 174	74 LS 174	0.93	1.64
0742 244	74 LS 244	1.18	1.93
0742 257	74 LS 257	1.11	1.85
0742 259	74 LS 259 (Alt to 74ALS259)	1.15	1.89

PART No	DESCRIPTION	RETAIL PRICE EXC U.A.T.	POSTAL PRICE INC U.A.T.
0742 373	74 LS 373 (Alt to 74ALS373)	1.16	1.91
0748 000	74 F 00	1.05	1.78
0748 074	74 F 74	1.05	1.78
0749 253	74 HCT 253	0.96	1.68
0770 324	LM 324	0.91	1.62
0770 386	LM 386	1.16	1.91
0780 177	FET J 177	1.40	2.18
0780 239	Transistor BC 239	0.36	0.99
0780 309	Transistor BC 309	0.36	0.99
0794 148	Diode 1N4148	0.11	0.70
0799 000	Red LED	0.33	0.95
0800 001	Socket MAB5WH (RS432)	0.93	1.64
0800 002	Socket MAB6H (RGB)	1.05	1.78
0800 003	Socket MAB7SHL (Cassette)	1.08	1.82
0800 004	Socket MAB5SH (Econet)	0.91	1.62
0800 006	PCB Header 34 way	1.85	2.70
0800 007	PCB Header 40 way	2.00	2.87
0800 008	PCB Header 26 way	1.60	2.41
0800 009	PCB Header 20 way	1.50	2.30
0800 043	Edge Connector 44 way	2.60	3.56
0800 050	Molex Pins 2 way	0.26	0.88
0800 051	Molex Pins 3 way	0.38	1.01
0800 067	Wafer 5 way	0.91	1.62
0800 070	Molex Mini Shunt	0.38	1.01
0800 080	Crimp Terminal	0.16	0.76
0800 082	Molex Housing 1 Pin SKT.	0.30	0.92
0800 083	Housing 3 way	0.78	1.47
0800 091	Wafer 2 way	0.81	1.51
0800 128	IC Socket 28 way	0.70	1.38
0800 203	Faston Tab .25"	0.33	0.95
0800 304	Socket 15 way 'D' Type	2.45	3.39
0800 455	Wafer 15 way	0.96	1.68
0800 481	Socket Housing 5 way	0.90	1.61
0800 482	Socket Housing 12 way	1.05	1.78
0800 483	Socket Housing 19 way	1.65	2.47
0800 600	Socket BNC 75 ohm	1.50	2.30
0800 611	Socket Phono (Video)	1.16	1.91
0801 200	Connector 20 way	1.30	2.07
0810 001	Cassette Relay	1.90	2.76
0820 160	Crystal 16MHz	1.60	2.41
0820 177	Crystal 17MHz	1.60	2.41
0821 327	Crystal 32.768MHz	0.83	1.53
0825 000	UHF Modulator UM 1233	5.40	6.78
0831 106	Master PSU	60.14	73.76
0835 003	Loudspeaker	1.50	2.30
0860 005	Choke 33mH	0.91	1.62
0882 947	Spire Clips No.4	0.16	0.76
0886 003	Keyswitch	0.86	1.57
0890 000	Rubber Feet	0.33	0.95

Telephone 061-429 0626

PART No	DESCRIPTION	RETAIL PRICE EXC U.A.T.	POSTAL PRICE INC U.A.T.
----- <u>Master EI</u>			
0201 530	Econet Lead (5-5)	1.33	2.10
2201 180	A.N.F.S. ROM	22.50	26.45
2201 254	ROM 1/2Mb	29.25	34.21
0706 854	68 B 54	8.75	10.63
0742 123	74 LS 123	1.20	1.95
0770 319	LM 319	3.00	4.02
0800 052	Molex Pins 5 way	0.56	1.22
0800 059	Molex Pins 17 way	0.86	1.57
0884 059	Plastic BCB Spacer	0.16	0.76
----- <u>Master Compact Keyboard</u>			
0158 001	Keyboard Assy.	40.00	49.46
0999 425	Keytop Set	23.33	27.98
0999 423	Ribbon Cable Assy.	12.05	14.43
0999 424	L.E.D.	1.35	2.12
0252 702	Handset Shutter	0.31	0.93
0252 704	UHF Shutter	0.31	0.93
0201 248	Plastic Boot	0.33	0.95
0201 647	Video ULA	18.00	21.27
0201 847	MSI I/I (CF30050)	16.45	19.49
2201 213	MSI MEM (CF30058)	12.60	15.06
0201 845	MSI PCB (CF30049)	12.70	15.18
0201 846	MSI CRTX MUX (CF30048)	12.70	15.18
0258 011	System ROM	35.40	41.28
0258 010	Wecome/Util Disc	11.50	14.37
0701 770	WD1770 FDC	36.86	42.96
0702 220	PCD8572 NV MEM	4.91	6.22
0704 105	64K x 4 D-RAM	8.10	9.89
0705 050	SAA 5050	10.50	12.65
0706 489	SN76489	7.10	8.74
0706 512	CPU 655C12	11.40	13.68
0706 522	6522	6.10	7.59
0706 854	6854	8.50	10.35
0740 016	7416 (Alt to 7406)	1.40	2.18
0740 038	7438	0.93	1.64
0741 004	74 S 04	0.93	1.64
0742 000	74 LS 00 (Alt to 74ALS00)	0.93	1.64
0742 002	74 LS 02	0.90	1.61
0742 014	74 LS 14	0.90	1.61
0742 086	74 LS 86	0.86	1.57
0742 139	74LS139 (Alt to 74HCT139)	1.08	1.82
0742 156	74 LS 156	1.00	1.72
0742 163	74LS163 (Alt to 74ALS163)	1.35	2.12
0742 174	74 LS 174	0.93	1.64
0742 244	74 LS 244	1.18	1.93
0742 251	74LS251 (Alt to 74HCT251)	1.05	1.78
0742 257	74LS257 (Alt to 74ALS257)	1.11	1.85

PART No	DESCRIPTION	RETAIL PRICE EXC U.A.T.	POSTAL PRICE INC U.A.T.
0742 259	74LS259 (Alt to 74ALS259)	1.15	1.89
0742 373	74LS373 (Alt to 74ALS373)	1.16	1.91
0747 030	74 HC 30	0.91	1.62
0748 000	74 F 00	1.05	1.78
0748 074	74 F 74	1.05	1.78
0749 253	74 HCT 253	0.96	1.68
0770 386	LM 386	1.16	1.91
0780 239	BC 239	0.36	0.99
0780 309	BC 309	0.36	0.99
0794 148	Diode 1N4148	0.11	0.70
0800 001	Socket MAB5WH (RS432)	0.93	1.64
0800 002	Socket MAB6H (RGB)	1.05	1.78
0800 004	Socket MAB5SH (Econet)	0.91	1.62
0800 050	Molex Pins 2 way	0.26	0.88
0800 051	Molex Pins 3 way	0.38	1.01
0800 070	Molex Minishunt	0.38	1.01
0800 080	Crimp Terminal	0.16	0.76
0800 082	Molex Housing 2 pin	0.30	0.92
0800 108	IC Socket 8 pin	0.36	0.99
0800 116	IC Socket 16 pin	0.56	1.22
0800 124	IC Socket 24 pin	0.56	1.22
0800 128	IC Socket 28 pin	0.70	1.38
0800 300	Socket 'D' 25 way	7.25	8.91
0800 313	Plug 9 way R/A Type	1.80	2.64
0800 365	Socket 24 way R/A Type	5.00	6.32
0800 481	Socket Housing 5 way	0.90	1.61
0800 484	Socket Housing 17 way	1.30	2.07
0800 616	Socket Phono (Video)	1.16	1.91
0801 001	PCB Power Socket	0.93	1.64
0801 300	Box Header 26 way	1.35	2.12
0820 160	Crystal 16 MHZ	1.60	2.41
0835 001	Loudspeaker	1.38	2.16
0890 001	Rubber Feet	0.31	0.93

Master Compact Disc

0158 108	Power Supply	43.37	54.48
0158 127	Cable Assy Drive Data	8.45	10.29
0258 105	Standoff	0.81	1.51
0258 116	Cable Assy IP Earth	0.95	1.66
0258 117	Cable Assy IP Fuse	0.86	1.57
0258 119	Cable Assy Fuse Switch	1.00	1.72
0258 120	Cable Assy Fuse OP	0.91	1.62
0258 121	Cable Assy OP Switch	0.90	1.61
0258 124	Cable Assy OP Earth	0.86	1.57
0258 131	Cable Assy Computer 5U	1.95	2.81
0800 207	Faston Tab 6.3mm	0.33	0.95
0800 246	Connector 5 way	0.83	1.53
0805 003	Rocker Switch	1.20	1.95
0815 250	Fuse 3A 15T	0.90	1.61

Telephone 061-429 0626

PART No	DESCRIPTION	RETAIL PRICE EXC U.A.T.	POSTAL PRICE INC U.A.T.
0815 900	Fuse Holder	1.98	2.85
0815 901	Fuse Holder Plastic Boot	0.81	1.51
0831 035	Disc Drive 3.5"	112.57	134.06
0865 901	Mains Plug 3way	1.13	1.87
0865 902	Mains Socket 3 way	1.13	1.87
0865 904	Boot For Mains Skt	0.85	1.55
0870 353	Mains Lead 0.75mm	6.90	8.51
0880 029	Grommet S/R	0.16	0.76
0880 052	Cable Clamp	1.45	2.24
0890 006	Rubber Feet	0.66	1.34

Master 512 Module

0143 210	512 Mouse	41.66	51.36
2201 287	LO Boot ROM	15.33	18.20
2201 288	HI Boot ROM	15.33	18.20
2201 226	CMOS Tube ULA	35.75	41.68
2201 289	512 Disc 1	6.86	9.04
2201 291	512 Disc 2	6.86	9.04
2201 293	512 Disc 3	6.86	9.04
2201 295	512 Disc 4	6.86	9.04
0700 187	80186	39.30	45.77
0704 107	256K x 1 D-RAM	7.75	9.48
0742 004	74 LS 04	1.05	1.78
0742 008	74 LS 08	1.00	1.72
0742 020	74 LS 20	0.75	1.43
0742 075	74 LS 75	0.86	1.57
0742 109	74 LS 109	1.06	1.80
0742 113	74 LS 113	0.86	1.57
0742 132	74 LS 132	1.25	2.01
0742 367	74 LS 367	0.88	1.59
0742 373	74 LS 373	1.16	1.91
0794 148	Diode 1N4148	0.11	0.70
0800 128	IC Socket 28 way	0.70	1.38
0800 140	IC Socket 40 way	0.81	1.51
0800 169	IC Socket 96 way	6.25	7.76
0800 452	Wafer 12 way	1.50	2.30
0820 201	Crystal 20 MHz	1.75	2.58
0884 059	Plastic PCB Spacer	0.16	0.76

Master Turbo Module

2201 181	Support Disc	7.26	9.50
2201 226	CMOS Tube ULA	35.75	41.68
2201 243	Boot ROM	12.46	14.91
0704 864	4164-15 D-RAM	4.00	5.17
0706 102	65 C 102	15.85	18.80
0742 000	74 LS 00	0.93	1.64
0742 002	74 LS 02	0.90	1.61
0742 020	74 LS 20	0.75	1.43

PART No	DESCRIPTION	RETAIL PRICE EXC U.A.T.	POSTAL PRICE INC U.A.T.
0742 073	74 LS 73	0.91	1.62
0742 109	74 LS 109	1.06	1.80
0742 133	74 LS 133	1.05	1.78
0742 257	74 LS 257	1.11	1.85
0742 393	74 LS 393	1.60	2.41
0742 590	74 LS 590	6.25	7.76
0800 140	IC Socket 40 way	0.81	1.51
0800 124	IC Socket 24 way	0.56	1.22
0800 452	Wafer 12 way	1.50	2.30
0820 160	Crystal 16 MHz	1.60	2.41
0884 059	Plastic PCB Spacer	0.16	0.76

Cassette

0201 521	Cassette Lead (7-7)	1.20	1.95
0999 484	Screw M/C Set M3x6	0.16	0.76
0999 485	Screw Set B/H M3x8	0.16	0.76
0999 486	Screw Set B/H M3x10	0.16	0.76
0999 487	Screw Set B/H M3x20	0.16	0.76
0999 488	Screw Set B/H M3x15	0.16	0.76
0999 489	Screw Taptite M2.6x6	0.16	0.76
0999 490	Bag Polly 2"x3"	0.16	0.76
0999 491	Bag Polly 10"x15"	0.16	0.76
0999 492	Bag Polly 4"x15"	0.16	0.76
0999 493	Polyfoam	0.73	1.41
0999 494	Box Gift	0.86	1.57
0999 496	Earphone 3.5mm	0.25	0.86
0999 467	Lable Gift Box	0.25	0.86
0999 498	Cardboard 'U' Shaped	0.75	1.43
0999 499	Polyfoam Flat 200x230	0.41	1.05
0999 500	Jack Socket PCB 3.5mm	0.33	0.95
0999 501	Socket DIN 7Pin	1.20	1.95
0999 502	Level Meter	4.65	5.92
0999 503	Loudspeaker 3 1/2"	1.90	2.76
0999 504	Control Volume Slide	0.73	1.41
0999 505	Socket VDE Type Mains	0.75	1.43
0999 506	Transformer 240V	2.75	4.31
0999 507	Switch Recording 9PDT	0.86	1.57
0999 508	Coil Biasing 621 JET	0.58	1.24
0999 509	Coil Motor Choke.	0.25	0.86
0999 510	TA7628P	2.10	2.99
0999 511	Transistor 2SC536F	0.86	1.57
0999 512	Diode CDG22	0.16	0.76
0999 513	Diode 1N60-5	0.16	0.76
0999 514	Diode 1N4001	0.16	0.76
0999 517	Knob Cassette	0.16	0.76
0999 518	Knob Record	0.16	0.76
0999 519	Door Cassette	1.20	1.95
0999 520	Door Battery	0.41	1.05
0999 521	Mounting Plate Jack	0.25	0.86

PART No	DESCRIPTION	RETAIL PRICE EXC U.A.T.	POSTAL PRICE INC U.A.T.
0999 522	Knob Tone & Volume	0.16	0.76
0999 523	Lens Cassette Door	0.50	1.15
0999 524	Handle Aluminium	1.35	2.12
0999 525	Contact Battery +ve	0.16	0.76
0999 526	Contact Battery -ve	0.25	0.86
0999 527	Contact Battery +ve & -ve	0.25	0.86
0999 528	Bracket Volume & Tone	0.41	1.05
0999 529	Spring Cassette Door	0.16	0.76
0999 530	Bracket Counter	0.25	0.86
0999 531	Clip Speaker Mounting	0.16	0.76
0999 532	Felt Volume & Tone	0.16	0.76
0999 533	Ring Rubber	0.16	0.76
0999 534	Mirror Cassette	0.16	0.76
0999 535	Plate Counter	0.16	0.76
0999 536	Plate Jack	0.16	0.76
0999 537	Belt Counter	0.41	1.05
0999 538	Counter	1.70	2.53
0999 539	Sponge Battery	0.16	0.76
0999 540	Screw Machine M2.6x4	0.16	0.76
0999 541	Screw Machine M3x5	0.16	0.76
0999 542	Screw Machine M3x6	0.16	0.76
0999 543	Screw Machine M2.6x6	0.16	0.76
0999 544	Screw Machine M2x4	0.16	0.76
0999 600	Plate Name	0.80	1.49
0999 601	Plate Model	0.40	1.03
0999 602	Belt Drive	2.80	3.79
0999 607	Head Rec./Pla./Era.	3.75	4.88
0999 612	Lead Mains	2.50	3.45
0999 628	Motor	8.08	10.44
0999 970	Transformer ALF03	11.13	15.10

Electron

0105 001	PSU PCB Assy.	22.80	27.37
0105 002	Keyboard Assy	39.66	49.06
0105 006	Electron User Cassette	8.33	10.73
0201 079	Keytop Set	22.00	26.45
0201 102	Ribbon Cable Assy	4.85	6.15
0201 113	Mains Adaptor	15.23	19.81
0201 248	Plastic Boot	0.33	0.95
0201 503	TV/Aerial Lead	1.21	1.97
0201 620	12C021 ULA	20.00	23.58
0201 621	O/S Basic ROM	14.93	17.74
0699 004	5.5-40pF Trimmer	0.81	1.51
0704 864	4164-15 D-RAM	4.00	5.17
0706 502	6502A	8.70	10.58
0741 004	74 S 04	0.93	1.64
0741 074	74 S 74	1.15	1.89
0742 000	74 LS 00	0.93	1.64
0742 074	74 LS 74	1.16	1.91

PART No	DESCRIPTION	RETAIL PRICE EXC U.A.T.	POSTAL PRICE INC U.A.T.
0742 086	74 LS 86	0.86	1.57
0743 169	74 LS 169a	1.45	2.24
0770 324	LM 324	0.91	1.62
0780 183	BC183L	0.31	0.93
0780 213	BC213L	0.31	0.93
0780 239	BC239	0.36	0.99
0780 309	BC309	0.36	0.99
0799 001	Miniture LED	1.10	1.84
0800 002	Socket MAB6H (RGB)	1.05	1.78
0800 003	Socket MAB7SKL (Cassette)	1.08	1.82
0800 168	IC Socket 68 way	14.25	16.96
0800 611	Socket Phono (Video)	1.16	1.91
0810 001	Cassette Relay	1.90	2.76
0820 160	Crystal 16 MHz	1.60	2.41
0820 177	Crystal 17 MHz	1.60	2.41
0825 000	UHF Modulator	5.40	6.78
0835 001	Loudspeaker	1.38	2.16
0860 005	Choke 33mH	0.91	1.62
0886 000	Space Bar Wire	0.16	0.76
0886 001	Wire Holder (Spacer Ring)	0.25	0.86
0886 002	Push Rod	0.23	0.84
0886 003	Keypress	0.86	1.57
0890 001	Rubber Feet	0.31	0.93
0999 599	Space Bar	0.81	1.51

Electron Plus 1

0201 752	ROM 32K	9.20	11.15
0700 844	ADC 0844	9.00	10.92
0742 000	74 LS 00	0.93	1.64
0742 004	74 LS 04	1.05	1.78
0742 010	74 LS 10	0.86	1.57
0742 020	74 LS 20	0.75	1.43
0742 027	74 LS 27	0.93	1.64
0742 030	74 LS 30	1.00	1.72
0742 032	74 LS 32	1.00	1.72
0742 125	74 LS 125	0.93	1.64
0742 139	74 LS 139	1.08	1.82
0723 175	74 LS 175	1.30	2.07
0742 195	74 LS 195	1.30	2.07
0742 260	74 LS 260	1.20	1.95
0742 273	74 LS 273	2.25	3.16
0780 238	BC 239	0.36	0.99
0800 038	Header 26 way	2.00	2.87
0800 043	Edge Connector 44 way	2.60	3.56
0800 044	PCB Socket 25 way	4.45	5.69
0800 305	Socket 'D' 15 way	2.50	3.45
0890 001	Rubber Feet	0.31	0.93

Telephone 061-429 0626

PART No	DESCRIPTION	RETAIL PRICE EXC U.A.T.	POSTAL PRICE INC U.A.T.
---------	-------------	----------------------------------	----------------------------------

Electron Plus 3

0141 000	Util/Disc Media	15.00	18.40
2201 035	Anti Interference Lable	0.58	1.24
0201 284	Disc Drive Bkt R.H.	0.91	1.62
2201 034	Disc Drive Bkt L.H.	1.06	1.80
0201 427	A.D.F.S.ROM	13.60	16.21
0201 943	Ribbon Cable Assy Disc IF	6.25	7.76
0201 944	Ribbon Cable Assy Pwr	2.00	2.87
0201 950	Disc Drive Clamp Plate	0.93	1.64
0701 770	WD 1770	36.86	42.96
0703 524	SG3524BN	4.35	5.57
0740 016	7416	1.40	2.18
0742 174	74 LS 174	0.93	1.64
0780 072	F.E.T BUZ 72 A	2.25	3.16
0780 327	BC 327	2.70	3.68
0794 050	Diode SI BYU 28-50	1.00	1.72
0794 051	Diode SE BYU 28-100	1.06	1.80
0795 008	Diode Zener BZY976C16	0.31	0.93
0795 009	Diode SI Zener 5V1	0.31	0.93
0800 320	Edge Connector 48 way	4.70	5.98
0801 001	Power Socket PCB	0.93	1.64
0815 300	Fuse 3A15 SB	0.86	1.57
0830 040	Disc Drive 3 1/2"	85.71	103.17
0865 010	Mains Adaptor	27.55	35.13
0890 001	Rubber Feet	0.31	0.93
0980 023	Choke (Common Mode)	2.90	3.91
0980 028	Choke (Output)	0.93	1.64
0980 026	Transformer Flyback	7.50	9.77

Miscellaneous

0104 001	Teletext PSU	23.30	30.24
0201 270	Teletext Ruler	0.20	0.80
0201 906	Teletext ROM PD93	13.33	15.90
0201 619	2732 Prog to PET Spec.	11.66	13.99
0201 033	PET Cable 40 way	1.40	2.18
0201 034	PET Cable 34 way	1.40	2.18
0201 035	PET Cable 20 way	1.40	2.18
0201 036	PET Cable 26 way	1.40	2.18
0201 037	PET Cable 6 way	1.40	2.18
0201 038	PET Cable 20 way 'D' type	1.40	2.18
0201 039	PET Cable 40 way Buffer	1.40	2.18
0201 040	FIT Cable 34 way	0.66	1.34
0201 041	FIT Cable 20 way	0.66	1.34
0201 042	FIT Cable 26 way	0.66	1.34
0201 043	FIT Cable 20 way 'D' Type	0.66	1.34
0820 018	Crystal 1.8432 MHz	12.50	14.95
0865 009	Transformer (Clock Box)	13.80	19.32

Telex 312242 · Mid Telex DRAM

PART No	DESCRIPTION	RETAIL	POSTAL
		PRICE	PRICE
		EXC	INC
		U.A.T.	U.A.T.

Books

0433 000	BBC & B+ User Guide	13.00	14.50
0433 001	BBC & B+ Service Manual	23.33	24.83
0403 700	DFS User Guide	8.33	9.83
0408 000	6502 User Manual	8.33	9.83
0408 003	6502 Service Manual	12.50	14.00
0409 010	Z80 User Guide	8.33	9.83
0409 015	Z80 Service Manual	20.83	22.33
0201 307	Prestel Function Strip	0.21	0.71
0415 000	Prestel User Guide	8.33	9.83
0415 001	Prestel Service Manual	20.83	22.33
2201 135	M128 Function Keycard Str	0.45	0.95
2201 139	Viewsheet Reference Card	0.91	1.41
0443 000	M128 Welcome Guide	13.00	14.50
0443 004	Master Service Manual	20.70	22.20
0458 000	Compact Welcome Guide	13.00	14.50
0458 002	Compact Service Manual	14.00	15.50
0458 001	Logotron User Guide	4.16	5.16
2201 138	View Reference Card	0.91	1.41
0458 012	View & ABC Keycard	0.56	1.06
2201 364	GEM Function Keystrip	0.91	1.41
0443 200	512 User Guide	13.00	14.50
0443 030	Turbo User Guide	6.50	7.50
0405 000	Electron User Guide	9.16	10.66
0405 001	Electron Service Manual	9.16	10.66
0405 002	Electron Programming Book	11.58	12.58
0419 100	Plus 1 User Guide	8.33	9.33
0441 000	Plus 3 User Guide	8.33	9.33
0201 905	PET Manual	8.33	9.33
0403 008	FIT Manual	8.33	9.33
0403 015	FIT Manual for Test Stati	4.16	5.16
0450 000	Music 500 User Guide	8.33	9.33
0999 428	Information Manual Vol.1	58.33	61.33
0999 483	Information Manual Vol.2	58.33	61.33

Cases

PLEASE NOTE THAT CASES ARE ONLY SUPPLIED IN MATCHED SETS

{103 002}	{BBC Case Set Upper}	28.00	35.65
{103 004}	{BBC Case Set Lower}		
{201 109}	{2nd Processor Case Upper}	12.80	17.02
{201 110}	{2nd Processor Case Lower}		
{999 515}	{Top Cabinet Recorder }	4.86	7.89
{999 516}	{Bottom Cabinet Recorder}		

Telephone 061-429 0626

PART No	DESCRIPTION	RETAIL PRICE EXC U.A.T.	POSTAL PRICE INC U.A.T.
{201 789} {201 791}	{Master Case Lower} {Master Case Upper}	24.15	31.22
{258 001} {258 002}	{Compact Case Upper} {Compact Case Lower}	15.83	20.50
{258 100} {258 101}	{Case Upper Wrap} {Case Lower Wrap}	31.20	39.33
{258 103} {258 104} {258 115}	{Case Moulding Set} { } { }	7.75	11.21
{201 080} {201 081}	{Electron Case Upper} {Electron Case Lower}	13.00	17.25
{201 276} {201 277}	{+3 Case Lower} {+3 Case Upper}	12.33	16.48
201 278	+3 Case Front	0.80	1.49
999 608	+1 Case Set	8.16	10.54

LabelsPLEASE NOTE THAT LABELS ARE ONLY SUPPLIED IN SETS

{201 096} {201 098} {201 111}	{BBC Label Set} { } { }	4.30	5.52
{201 103} {201 106}	{6502 Label Set} { }	2.00	2.87
{201 108} {201 742}	{280 Label Set} { }	3.30	4.37
{201 182} {201 184}	{Prestel Label Set} { }	1.90	2.76
999 420	Master Label Set	4.25	5.46
{258 003} {258 004} {258 005}	{Compact Label Set} { } { }	3.80	4.94
{258 111} {258 114}	{Compact Front Label Small} {Compact Front Label Large}	1.43	2.22

Telex 312242 · Mid Telex DRAM

PART No	DESCRIPTION	RETAIL PRICE EXC U.A.T.	POSTAL PRICE INC U.A.T.
{288 112}	{Compact Rear Lable}	1.45	2.24
{258 125}	{Compact Bottom Lable}		
201 112	Electron Case Lable	0.91	1.62
201 918	Top Case Lable +3	0.45	1.09

Slogger Products

Electron/BBC Software

Starword	30.00	35.65
Starstore 2	26.05	31.11
Starmon	17.65	21.45
PDG	8.65	11.10
Stargraph	19.08	23.09
Printer ROM	17.65	21.45
Startrek	15.55	18.95

Electron Software

Starstore	19.08	23.09
Elkman	13.00	16.10
T2P3	21.70	26.11
T2CU	21.70	26.11
T2P4	21.70	26.11
S.E.D.F.S.	21.70	26.11
Plus 1 ROM	10.39	13.10

Electron Hardware

MR2	47.79	56.11
Rombox	39.09	46.10
Rombox Plus	47.78	56.10
Turbodriver	25.05	29.96
16K RAM Card	25.05	29.96
Cartridge	11.27	14.11
Joystick Interface	17.65	21.45

Telephone 061-429 0626

AERIAL ACCESSORIES

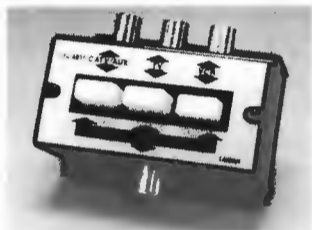

T.V. SWITCH

T123A EUAB37

Pushbutton selector switch to give three inputs to one TV. Blue body with aluminium faceplate. Co-axial socket inputs, co-axial plug output. Automatic substitution of 75Ω load when channel not in use. Screw fixing.

Dims:- 90 x 47 x 39mm



T124 T.V. SWITCH EUSW76

Two input, 75Ω, high isolation selector switch for changing TV input signal. Can be used with TV aerial, VCR, micro-computer, TV game, etc. Zinc diecast inner housing with moulded outer case. Automatic substitution of 75Ω load resistor when input channel not in use. Input via co-axial sockets. Output via 100cm flying lead. Fixing by screws or adhesive pads.

Band width:- d.c. to 900MHz
 Isolation:- 80dB min.
 Impedance:- 75Ω
 Dims:- 80 x 77 x 27mm

T.V. SWITCH

T125 EUSW78

As above but output via co-axial socket.



T.V. SWITCH UNIT

T126 EUAB59

Multi-channel selector system for TV/video signals, housed in attractive wooden cabinet. Pushbutton switch selection of four inputs to three outputs. Connection by Co-axial sockets.

Inputs:- ... VCR; Antenna; Cable TV; TV game; Computer

Outputs:- Main TV; remote TV; VCR
 Isolation:- 80dB
 Insertion loss:- 3.5 - 10dB
 Dims:- 247 x 140 x 80mm

Prices (inc post& VAT)

T123A	4.40	T124	5.14	T126	30.75
F361	1.20	F361A	1.40	T151	.60
T152	.60	T153	.70	T152A	2.40
T153A	1.40	T153B	1.40	T153C	1.40
T150A	23.53	T150B	25.88	T150C	25.88
T150D	23.53	T154	8.26	T155	10.60

	F361	1801A	Aerial splitter, giving two standard co-axial outlets from one input. Incorporates ferrite cores for lower loss.
	F361A	3693	Switched changeover adaptor. Incorporates miniature slide switch. Input: co-axial. Output: co-axial.

COMPUTER CASSETTE TAPES



High quality low noise cassette tapes. Short play leaderless construction for use with computer cassette systems. Each tape in individual plastic library case with index card.

ref.	cat.	playing time
T151	C10	10 minutes
T152	C15	15 minutes
T153	C20	20 minutes



T152A

Pack of five, high quality, low noise, C15 15 minute cassette tapes in clear plastic library case. Leaderless construction for use with computer systems.

C15B5



Top quality modern styled computer compatible cassette tapes. Transparent plastic bodies with twin METAL SPOOLS. Packed in library case.

ref.	cat.	playing time
T153A	RC10	10 minutes
T153B	RC15	15 minutes
T153C	RC20	20 minutes

DATA RECORDERS

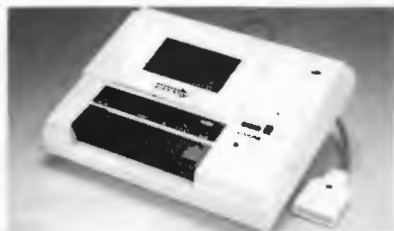

DATA RECORDER

T150A

PM4401C

High quality computer data recorder suitable for use with VIC-20 and COMMODORE 64 computers. Preset record and playback levels to be compatible with computer. Robust cream ABS body with brown 'piano' control keys. Tape counter. Auto stop.

Power:-..... Powered from computer
Lead length:-..... 1.35m
Dims:-..... 197 x 158 x 53mm



DATA RECORDER

T150B

C682A

High quality battery/DC operated data recorder suitable for use with most home computers. Internal switchable piezo buzzer for monitoring input/output. Slider level control. Auto stop. Tape counter. Connections via miniature jack plugs or by 5-pin DIN plug.

Input impedance:-..... 2k Ω
Output:-..... 3.5V p/p square wave
Output impedance:-..... 68 Ω
Tape speed:-..... 4.75cm/sec
Power:-..... 4 x 'AA' batteries or external 6Vd.c. 200mA supply
Dims:-..... 206 x 132 x 50mm

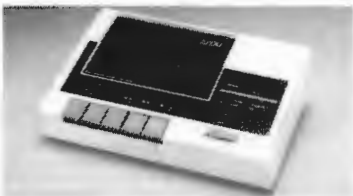

DATA RECORDER

T150C

C683A

High quality mains/battery operated data recorder suitable for use with most home computers. Internal switchable piezo buzzer for monitoring input/output. Rotary level control. Auto stop. Tape counter. Connections via miniature jack plugs or by 5-pin DIN plug.

Input impedance:-..... 2k Ω
Output:-..... 3.0V p/p square wave
Output impedance:-..... 100 Ω
Tape speed:-..... 4.75cm/sec
Power:-..... 240Va.c. 50Hz or 4 x 'AA' batteries
Dims:-..... 206 x 132 x 50mm



DATA RECORDER

T150D

PCM16

High quality computer data recorder suitable for use with VIC-20 or COMMODORE 64 computers. Plugs directly into computer and takes its power from the same connector. Record and play-back levels are preset to be compatible with computer input and output. Two-tone brown and fawn ABS body with "piano" control keys.

Power:-..... Powered from computer
Lead length:-..... 1.3m
Dims:-..... 195 x 158 x 52mm

FLOPPY DISC HEAD CLEANERS



DRY TYPE CLEANER

T154

5DT11

High quality DRY TYPE floppy disc driver head cleaner. Comprises two cleaning discs made from lint-free fibres. Simply insert cleaner and run for 20 seconds. Each cleaner suitable for 15 operations. Suitable for use with single or double sided disc drives.

Dims:-..... 5.125 inch ANSI

WET TYPE CLEANER

T155

5WT01

Professional Quality WET TYPE floppy disc head cleaner. Six discs made from non-woven polyester (random fibre) with one jacket. Complete with aerosol spray sufficient for fifteen operations per cleaning disc. Suitable for single or double sided disc drives.

Disc size:-..... 5.125 inch ANSI

JOYSTICKS AND TRACKBALLS

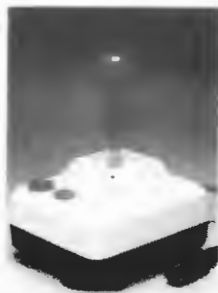

DRAGON

T159A DR2B

Rugged easy action analogue joystick with centre return springs. Internal variable pots give direct analogue output. Large, solid body with sucker feet. Two 'fire' buttons. Metal shaft with large round handle.

Dims:- 115 x 98 x 150mm
Handle length:- 100mm



BBC

T159C VG318BBC

Purpose built joystick compatible with the analogue input of the BBC. Internal resistors give the required voltage levels. Strong mechanism with light action. Two 'fire' buttons. Rubber suction feet.

Dims:- 120 x 110 x 155mm
Handle length:- 130mm

DRAGON

T159D VG318DRA

As above but fitted with 5-pin 240° DIN plug for use with Dragon and Tandy Colour computers.



BBC

T159F TUK282

Purpose built digital joystick compatible with the analogue input of the BBC. Internal resistors give the required voltage levels. Strong mechanism with light action. Thumb and pressure bar 'fire' buttons. Rubber suction feet.

Dims:- 115 x 79 x 152mm
Handle length:- 122mm



ATARI

T165 JS2B

Top quality construction joystick with modern designed body and handle shaped to fit the hand. Four large suction feet attach firmly to any flat surface. 'Fire' button built into handle, and 'fire' pressure strip on body gives left- or right- handed operation. Membrane switches throughout. Fast, comfortable action. For use with 'ATARI' compatible games systems. Centre sprung. 1.25m lead to 9-pin in-line socket. Black plastic body with red 'fire' buttons.

Dims:- 114 x 80 x 90mm
Handle length:- 122mm

QUICKSHOT I

ATARI

T165A SVI101S

Deluxe digital joystick with hand contoured handle and two 'fire' buttons. Light, rugged action. Rubber suction feet.

Dims:- 107 x 88 x 160mm
Handle length:- 125mm



QUICKSHOT II

ATARI

T165C SVI102

A quality joystick with futuristic designed body and hand contoured handle. Light, rugged action. Thumb and forefinger 'fire' buttons and AUTO FIRE switch. Rubber suction feet.

Dims:- 130 x 95 x 175mm
Handle length:- 130mm



Prices (carriage FREE includes VAT)

T159C	7.40
T159D	7.40
T159F	8.80
T161	16.20
T161A	20.40
T165	4.40
T165A	7.00
T165C	11.30
T165D	11.30
T165E	11.30
T165F	7.40
T171	5.90
T173A	11.70
T174	4.40
T174A	4.40
T174B	2.70

COMPUTER ACCESSORIES



ATARI
T165D SV1104

A new concept in joysticks. Three interchangeable handles allow you to tailor the joystick to suit the game. Light rugged action. Rubber suction feet.

Dims:- 107 x 88 x 160mm
Handle lengths:- 125mm



MSX
T165E SV1105

Large, rugged joystick with futuristic design. Thumb and forefinger 'fire' buttons and enlarged 'fire' pad. Five rubber suction feet.

Dims:- 193 x 90 x 160mm
Handle length:- 113mm



ATARI
T165F SV1107

Handheld joystick controller. Compact size with lightweight fingerpad directional control. Thumb and forefinger 'fire' buttons. Left or right handed operation.

Dims:- 63 x 118 x 22mm

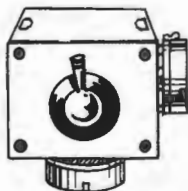

SKELETON POTS

Skeleton joystick potentiometers. Ideal for incorporation into computers, games etc. Tough metal construction. Two short sweep linear pots mounted at 90°. Plastic handle.

Dims:- (Body) 35 x 35 x 25mm

ref.	cat.	resistance
F118E	JS10	10K Ω
F118F	JS100	100K Ω

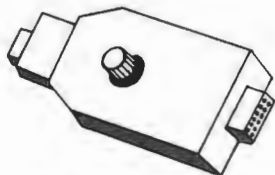

FIRE SPEED ADJUSTER

ATARI

T174 WF1601

Plug-in unit which lies between computer and joystick and uses internal circuitry to control the firing speed. Delay is variable from very slow to instantaneous. Adds another range of skill levels. 9-pin plug to 9-pin socket.

Dims:- (Body) 77 x 36 x 22mm

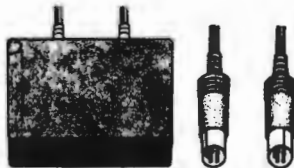

INTERFACE DRAGON

T171 AA1010

Interface unit to convert digital input (as obtained from Atari-compatible joysticks) to the correct analogue level for use with such home computers as Dragon, Tandy Colour, Radio Shack, etc. Two separate channels for competitive games. Two 5-pin 240° DIN plugs to compact case with two 9-pin plugs, with internal circuitry and connections for Atari-type joysticks. Black plastic.

Dims:- (Body) 116 x 62 x 29mm



INTERFACE SPECTRUM (KEMPSTON)

T173A M221

Plug-in 'Kempston' interface to make Atari type joysticks compatible to Spectrum computers with 'Kempston' programmes. Compact module has edge connector with polarity key and a short lead to a 9-pin plug.

Dims:- 74 x 63 x 16mm



INTERFACE ORIC

T174A ORIC83

Interface unit to convert outputs from Atari-type joysticks to be compatible with the ORIC microcomputer. Provision for two joysticks. 20-pin DIP connector used. Black plastic.

Dims:- (Body) 60 x 30 x 18mm

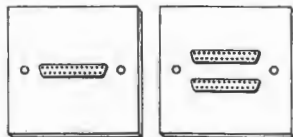

RS232 WALL PLATES

Industrial standard wall mounting plates with 25-pin 'D' sockets for inter-connection between computer hardware using the RS232 interface system. Standard fixing centres for normal single gang boxes.

Dims:- (plate) 85.5 x 85.5mm

ref.	cat.	description
T175	WD3101	single
T176	WD3102	double



AUTO FIRE ADAPTOR

T174B AD333

In-line adaptor which converts any Atari-compatible joystick into an auto-firing joystick. Simple operation - just plug in between Atari computer and joystick.

Overall dims:- 69 x 25 x 16mm

BBC Firmware (all on ROM)

Acorn Graphics	26.00
Basic Editor	26.04
BCPL	52.00
Comal	43.35
Disc Doctor	29.00
Edward II	39.95
Exmon II	27.83
Forth	43.35
Graphics	29.00
Help	26.96
Hiview	52.00
Iso Pascal	60.00
Lisp	43.35
Logo	60.00
Micro-Prolog	69.52
Murom	27.83
Printmaster	29.00
Sleuth	27.83
Spellcheck II	31.30
Termulator	30.00
Toolkit+	33.91
Toolstar	26.09
View	52.00
Viewsheet	52.00
Viewstore	52.00
View 3 ROM	78.00
View Index BBC	13.00
Wordwise Plus	49.00

Electron Software

Snapper	2.50
Starship Command	2.50
Boxer	2.50
Chess	2.50
Hopper	2.50
Arcadians	2.50
Sphinx Adventure	2.50
Desk Diary	2.50
Business Games	2.50
Picture Maker	2.50
Sentence Sequencing	2.50
Philosophers Quest	Cartridges 2.50
Hopper	" 9.00
View	9.00
Viewsheet	9.00

Cartridges for Electron

Viewsheet	10.00
Viewstore	10.00
Hopper	8.00